

## IDC 0,3/10-3,81

Order No.: 1706251

The figure shows a 10-position version of the product

<http://eshop.phoenixcontact.de/phoenix/treeViewClick.do?UID=1706251>

Printed circuit terminal block, nominal current: 5 A, rated voltage: 160 V, pitch: 3.81 mm, no. of positions: 10, mounting: Soldering, type of connection: Insulation displacement connection QUICKON, connection direction from the conductor to the PCB: 0°

### Commercial data

EAN	4017918116750
Pack	50 Pcs.
Customs tariff	85369010
Weight/Piece	0.00579 KG
Catalog page information	Page 101 (CC-2007)

### Product notes

WEEE/RoHS-compliant since:  
01/01/2003

<http://www.download.phoenixcontact.com>  
Please note that the data given here has been taken from the online catalog. For comprehensive information and data, please refer to the user documentation. The General Terms and Conditions of Use apply to Internet downloads.

### Technical data

#### Dimensions / positions

Pitch	3.81 mm
Dimension a	34.29 mm
Number of positions	10

Pin dimensions	1 x 0,4 mm
Hole diameter	1.3 mm

#### Technical data

Insulating material group	I
Rated surge voltage (III/3)	2.5 kV
Rated surge voltage (III/2)	2.5 kV
Rated surge voltage (II/2)	2.5 kV
Rated voltage (III/2)	160 V
Rated voltage (II/2)	320 V
Connection in acc. with standard	EN-VDE
Nominal current $I_N$	5 A
Nominal voltage $U_N$	160 V
Nominal cross section	0.34 mm <sup>2</sup>
Maximum load current	5 A (with 0.34 mm <sup>2</sup> conductor cross section)
Insulating material	PA
Inflammability class acc. to UL 94	V0

#### Connection data

Conductor cross section solid min.	0.13 mm <sup>2</sup>
Conductor cross section solid max.	0.34 mm <sup>2</sup>
Conductor cross section stranded min.	0.22 mm <sup>2</sup>
Conductor cross section stranded max.	0.34 mm <sup>2</sup>
Conductor cross section AWG/kcmil min.	26
Conductor cross section AWG/kcmil max	22

#### Certificates / Approvals



#### CSA

Nominal voltage $U_N$	300 V
Nominal current $I_N$	5 A
AWG/kcmil	28-22

**CUL**

Nominal voltage $U_N$	300 V
Nominal current $I_N$	5 A
AWG/kcmil	28-22

**UL**

Nominal voltage $U_N$	300 V
Nominal current $I_N$	5 A
AWG/kcmil	28-22
Certification	CSA, CUL, GOST, UL

**Accessories**

Item	Designation	Description
0804109	SK 3,81/2,8:FORTL.ZAHLEN	Marker card, printed horizontally, self-adhesive, 10-section marker strip, 14 identical decades marked 1-10, 11-20 etc. up to 91-(99)100, sufficient for 140 terminal blocks

**Marking**

**Drawings**

Drilling diagram

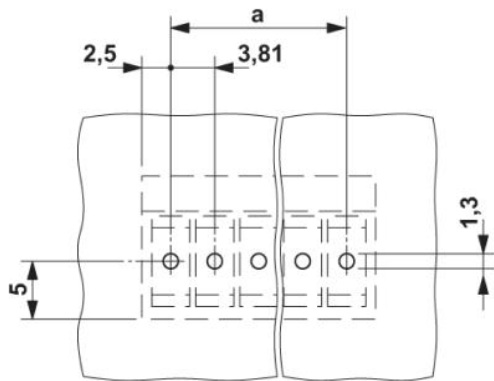

Diagram



- 1 = Limit values acc. to EN 50173 for connection technology
- 2 = NEXT 12-36 on the soldering tag
- 3 = NEXT 12-36 on the contact terminal block

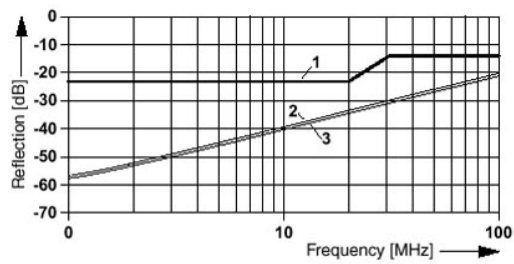

- 1 = Limit values acc. to EN 50173 for connection technology
- 2 = NEXT 12 on the soldering tag
- 3 = NEXT 36 on the soldering tag

Dimensioned drawing

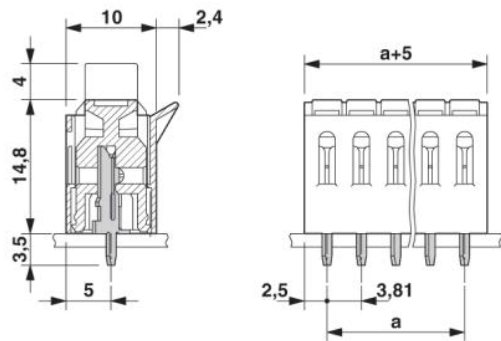

**Address**

PHOENIX CONTACT Inc., USA  
586 Fulling Mill Road  
Middletown, PA 17057, USA  
Phone (800) 888-7388  
Fax (717) 944-1625  
<http://www.phoenixcon.com>



© 2008 Phoenix Contact  
Technical modifications reserved;